

55500060030

D603 STNL A4 MUSHR SQR NECK BLT M6X30

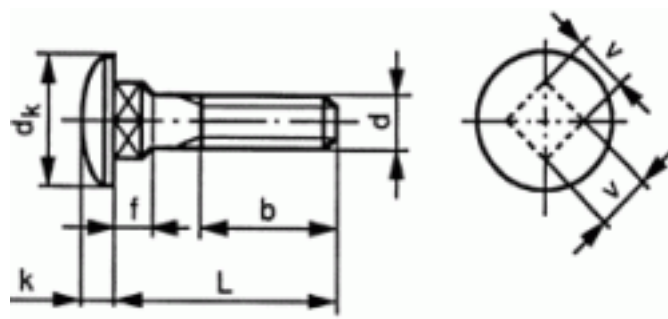

Brand	-
UBB Code	951351839943
UNSPSC Code	31161612
EAN Code	8715492346391
Thread	Metric thread
Material	Stainless steel
Material technical	A4



b (min.): 125mm<L≤200mm	24
b (min.): L≤125mm	18
v (max.)	6,48
k (max.)	3,88
f (max.)	4,6
dx (max.)	16,55
P	1
L	30
d	M6
Packaging (Piece)	50.0



Copyright Fabory Group