

12300160001

D985 |5| ZPL HX LCKNT/INS SP M16

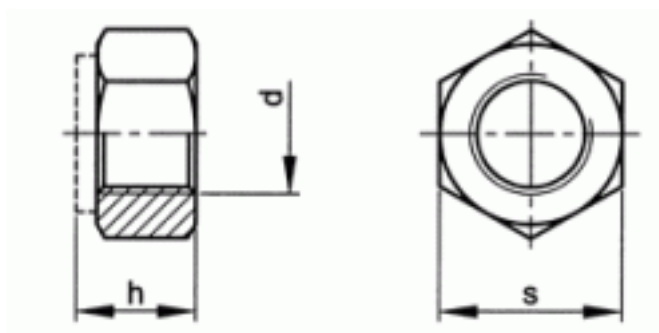

Brand	-
UBB Code	950355116415
UNSPSC Code	31161727
EAN Code	8715492576903
Driving features	hexagon
Thread	Metric thread
Class	≥ 5
Material	Steel
Surface treatment	Zinc plated



s	23
h	16
P	2
d	M16
Packaging (Piece )	50.0



Copyright Fabory Group