

3707010001

~D128A ST YLP SPR WASH VSK M10

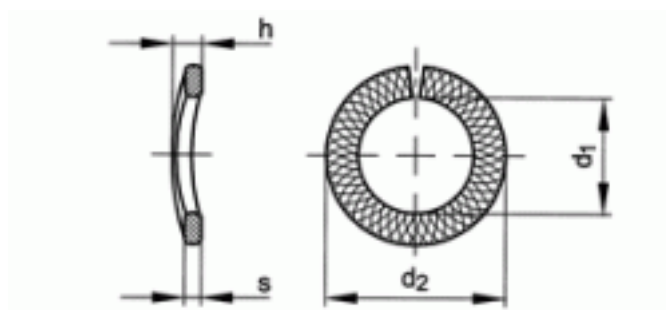

Brand	-
UBB Code	950357142294
UNSPSC Code	31161811
EAN Code	8715492765550
Surface treatment	Mechanical zinc plated yellow passivated
Material technical	DIN267-26
Material	Spring steel



For nom. size	M10
Packaging (Piece )	200.0



Copyright Fabory Group