

0412010001

D934 |10| HX NT M10

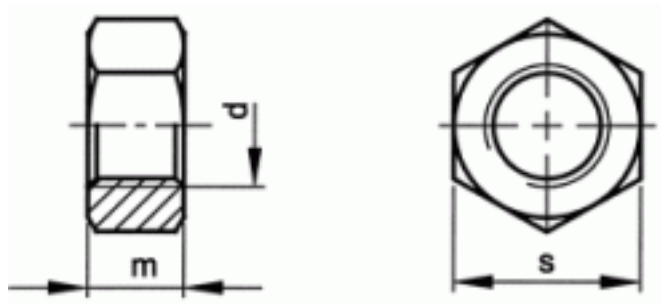

Brand	-
UBB Code	950355042736
UNSPSC Code	31161727
EAN Code	8715492119506
Driving features	hexagon
Material	Steel
Class	10
Thread	Metric thread



s	17
m	8
P	1,5
d	M10
Packaging (Piece)	250.0



Copyright Fabory Group