

55500100080

D603 STNL A4 MUSHR SQR NECK BLT M10X80

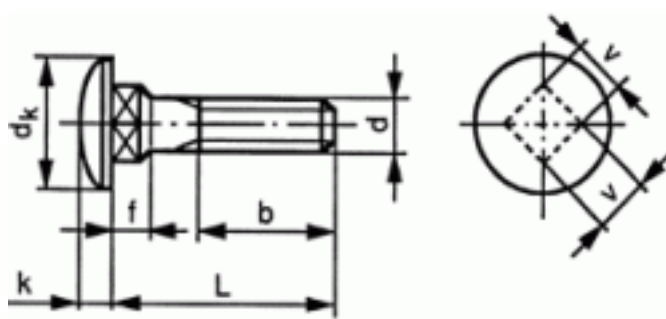

Brand	-
UBB Code	951351844893
UNSPSC Code	31161612
EAN Code	8715492346759
Thread	Metric thread
Material	Stainless steel
Material technical	A4



b (min.): L>200mm	45
b (min.): 125mm<L≤200mm	32
b (min.): L≤125mm	26
v (max.)	10,58
k (max.)	5,38
f (max.)	6,6
dx (max.)	24,65
P	1,5
L	80
d	M10
Packaging (Piece)	10.0



Copyright Fabory Group