

12300300001

D985 |5| ZPL HX LCKNT/INS SP M30

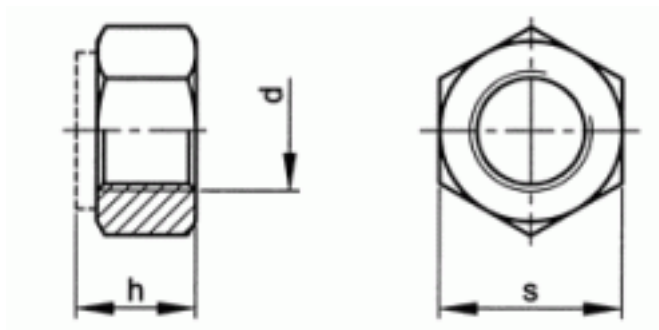

Brand	-
UBB Code	950355117082
UNSPSC Code	31161727
EAN Code	8715492576965
Driving features	hexagon
Thread	Metric thread
Class	≥ 5
Material	Steel
Surface treatment	Zinc plated



s	46
h	30
P	3,5
d	M30
Packaging (Piece )	10.0



Copyright Fabory Group