

12300080001

D985 |5| ZPL HX LCKNT/INS SP M8

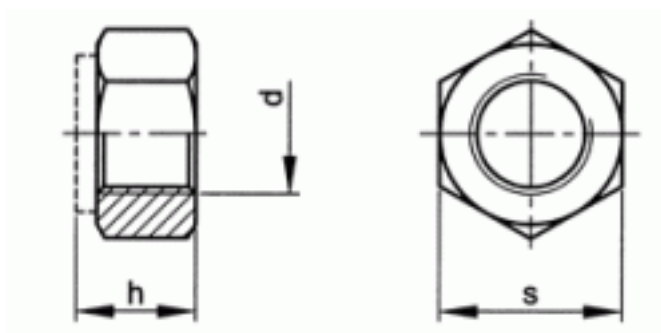

Brand	-
UBB Code	950355116092
UNSPSC Code	31161727
EAN Code	8715492576859
Driving features	hexagon
Thread	Metric thread
Class	≥ 5
Material	Steel
Surface treatment	Zinc plated



s	13
h	8
P	1,25
d	M8
Packaging (Piece )	250.0



Copyright Fabory Group