

55500080030

D603 STNL A4 MUSHR SQR NECK BLT M8X30

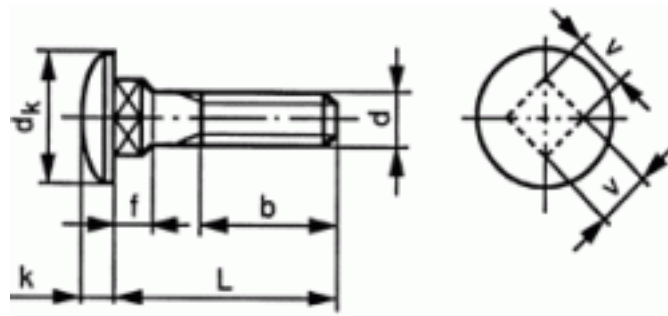

Brand	-
UBB Code	951351841824
UNSPSC Code	31161612
EAN Code	8715492346544
Thread	Metric thread
Material	Stainless steel
Material technical	A4



b (min.): L>200mm	41
b (min.): 125mm<L≤200mm	28
b (min.): L≤125mm	22
v (max.)	8,58
k (max.)	4,88
f (max.)	5,6
dx (max.)	20,65
P	1,25
L	30
d	M8
Packaging (Piece )	50.0



Copyright Fabory Group