

Data Sheet | Item Number: 285-194

2-conductor through terminal block; 95 mm²; lateral marker slots; only for DIN 35 x 15 rail; POWER CAGE CLAMP; 95,00 mm²; blue

<https://www.wago.com/285-194>

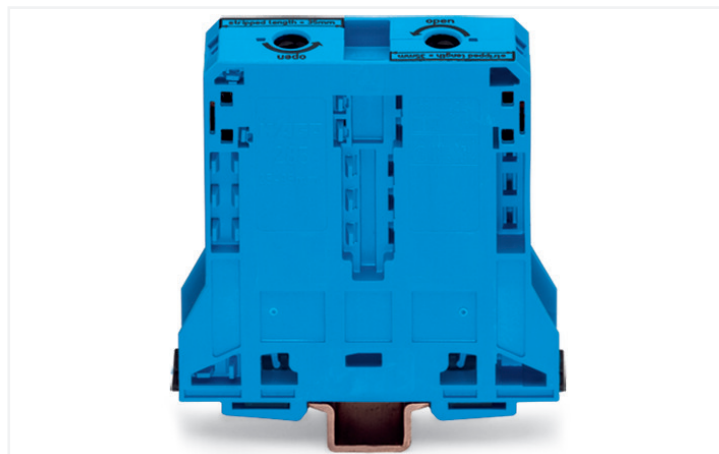
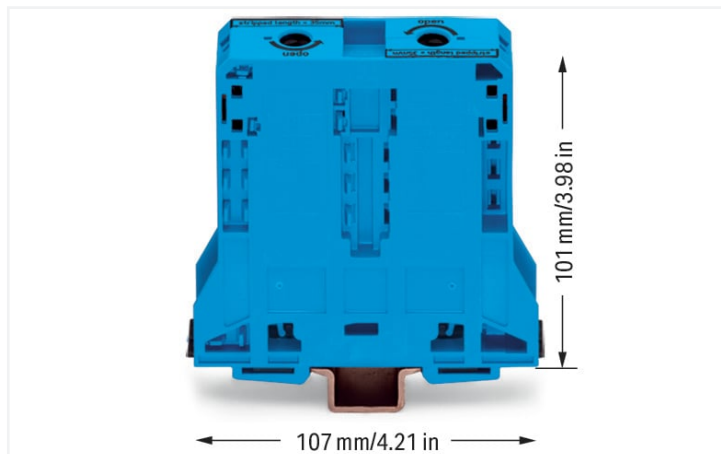

Color: ■ blue

Electrical data

Ratings per	IEC/EN 60947-7-1		
Overvoltage category	III	III	II
Pollution degree	3	2	2
Nominal voltage	1000 V	-	-
Rated surge voltage	12 kV	-	-
Rated current	232 A	-	-

Ratings per IEC/EN 2	
Rated voltage (III/3) 2	1500 V
Rated surge voltage (III/3) 2	12 kV

Approvals per	UL 1059		
Use group	B	C	D
Rated voltage	600 V	600 V	-
Rated current	200 A	200 A	-

Approvals per	CSA 22.2 No 158		
Use group	B	C	D
Rated voltage	1000 V	1000 V	-
Rated current	210 A	-	-

Power Loss	
Power loss, per pole (potential)	7.5354 W
Rated current I_N for specified power loss	232 A
Resistance value for specified, current-dependent power loss	0.00014 Ω

General information	
Voltage type 1	AC/DC
Voltage type 2	DC

Connection data

Connection points	2
Total number of potentials	1
Number of levels	1
Number of jumper slots	2

Connection 1	
Connection technology	POWER CAGE CLAMP
Actuation type	T-wrench; 8 mm
Connectable conductor materials	Copper
Nominal cross-section	95 mm ²
Solid conductor	25 ... 95 mm ² / 4 ... 4/0 AWG
Stranded conductor	25 ... 95 mm ² / 4 ... 4/0 AWG
Fine-stranded conductor	25 ... 95 mm ² / 4 ... 4/0 AWG
Fine-stranded conductor; with insulated ferrule	25 ... 95 mm ² / 4 ... 4/0 AWG
Fine-stranded conductor; with uninsulated ferrule	25 ... 95 mm ² / 4 ... 4/0 AWG
Strip length	35 mm / 1.38 inches
Wiring direction	Side-entry wiring

Physical data

Width	25 mm / 0.984 inches
Height	107 mm / 4.213 inches
Depth from upper-edge of DIN-rail	101 mm / 3.976 inches

Mechanical data

Mounting type	DIN-rail 35 x 15
Mounting (note)	only suitable for DIN 35 x 15 rail
Marking level	Side marking

Material data

Note (material data)	Information on material specifications can be found here
Color	blue
Material group	I
Insulation material	Polyamide (PA66)
Flammability class per UL94	V0
Fire load	3.532 MJ
Weight	263.2 g

Environmental requirements

Processing temperature	-35 ... +85 °C
Continuous operating temperature	-60 ... +105 °C

Commercial data

Product Group	1 (Rail Mounted Terminal Blocks)
eCl@ss 10.0	27-14-11-20
eCl@ss 9.0	27-14-11-20
ETIM 8.0	EC000897
ETIM 7.0	EC000897
PU (SPU)	5 pcs
Packaging type	Box
Country of origin	PL
GTIN	4044918452533
Customs tariff number	85369010000

Environmental Product Compliance

RoHS Compliance Status	Compliant, No Exemption
------------------------	-------------------------

Approvals / Certificates

General approvals



Approval	Standard	Certificate Name
CCA DEKRA Certification B.V.	EN 60947	NTR NL-7707
CSA DEKRA Certification B.V.	C22.2 No. 158	154112
KEMA/KEUR DEKRA Certification B.V.	EN 60947	71-105562

Declarations of conformity and manufacturer's declarations

Approval	Standard	Certificate Name
EU-Declaration of Conformity WAGO GmbH & Co. KG	-	-
UK-Declaration of Conformity WAGO GmbH & Co. KG	-	-

Approvals for marine applications



Approval	Standard	Certificate Name
ABS American Bureau of Ship- ping	EN 60947	20-HG1941090-PDA
BV Bureau Veritas S.A.	EN 60947	07436/F0 BV
DNV GL Det Norske Veritas, Ger- manischer Lloyd	-	TAE00001V2
LR Lloyds Register	EN 60947	91/20112 (E9)

Downloads

Environmental Product Compliance

Compliance Search
Environmental Product Compliance 285-194 ↓

Documentation

Additional Information		
Technical Section	pdf 2240.62 KB	↓

Bid Text				
285-194	19.02.2019	xml 3.23 KB	↓	
285-194	04.01.2018	doc 23.50 KB	↓	

CAD/CAE-Data

CAD data
2D/3D Models 285-194 ↓

CAE data	
EPLAN Data Portal 285-194	↓
WSCAD Universe 285-194	↓
ZUKEN Portal 285-194	↓

1 Compatible Products

1.1 Optional Accessories

1.1.1 Cover

1.1.1.1 Cover



Item No.: 285-169

Finger guard; touchproof cover protects unused conductor entries and jumper slots; for 95 mm² high-current tbs; yellow

1.1.2 Current and voltage tap

1.1.2.1 Current and voltage tap



Item No.: 855-951/250-000

Current and voltage tap up to 95 mm²; Primary rated current: 250 A; Secondary rated current: 1 A; Rated power: 0.2 VA; Accuracy class: 0.5; fused

1.1.3 DIN-rail

1.1.3.1 Mounting accessories



Item No.: 210-198

Copper carrier rail; 35 x 15 mm; 2.3 mm thick; 2 m long; unslotted; according to EN 60715; copper-colored



Item No.: 210-508

Steel carrier rail; 35 x 15 mm; 1.5 mm thick; 2 m long; slotted; galvanized; similar to EN 60715; silver-colored



Item No.: 210-197

Steel carrier rail; 35 x 15 mm; 1.5 mm thick; 2 m long; slotted; similar to EN 60715; silver-colored



Item No.: 210-506

Steel carrier rail; 35 x 15 mm; 1.5 mm thick; 2 m long; unslotted; galvanized; similar to EN 60715; silver-colored



Item No.: 210-114

Steel carrier rail; 35 x 15 mm; 1.5 mm thick; 2 m long; unslotted; similar to EN 60715; silver-colored

1.1.4 Ferrule

1.1.4.1 Ferrule



Item No.: 216-435

Ferrule; Sleeve for 50 mm² / AWG 1; un-insulated; electro-tin plated; electrolytic copper; gastight crimped; acc. to DIN 46228, Part 1/08.92

1.1.5 Installation

1.1.5.1 Mounting accessories



Item No.: 285-168

Fixing element; for 95 mm² high-current terminal blocks; orange

Item No.: 249-197

Screwless end stop; 14 mm wide; for DIN-rail 35 x 15 and 35 x 7.5; gray

1.1.6 Jumper

1.1.6.1 Jumper



Item No.: 285-495

Jumper; insulated; gray

1.1.7 Marking

1.1.7.1 Group marker carrier



Item No.: 249-105

Group marker carrier; gray

1.1.7.2 Marker



Item No.: 793-5501/000-006

WMB marking card; as card; for terminal block width 5 - 17.5 mm; stretchable 5 - 5.2 mm; plain; snap-on type; blue



Item No.: 793-5501/000-014

WMB marking card; as card; for terminal block width 5 - 17.5 mm; stretchable 5 - 5.2 mm; plain; snap-on type; brown



Item No.: 793-5501/000-007

WMB marking card; as card; for terminal block width 5 - 17.5 mm; stretchable 5 - 5.2 mm; plain; snap-on type; gray



Item No.: 793-5501/000-023

WMB marking card; as card; for terminal block width 5 - 17.5 mm; stretchable 5 - 5.2 mm; plain; snap-on type; green



Item No.: 793-5501/000-017

WMB marking card; as card; for terminal block width 5 - 17.5 mm; stretchable 5 - 5.2 mm; plain; snap-on type; light green



Item No.: 793-5501/000-012

WMB marking card; as card; for terminal block width 5 - 17.5 mm; stretchable 5 - 5.2 mm; plain; snap-on type; orange



Item No.: 793-5501/000-005

WMB marking card; as card; for terminal block width 5 - 17.5 mm; stretchable 5 - 5.2 mm; plain; snap-on type; red



Item No.: 793-5501/000-024

WMB marking card; as card; for terminal block width 5 - 17.5 mm; stretchable 5 - 5.2 mm; plain; snap-on type; violet



Item No.: 793-5501

WMB marking card; as card; for terminal block width 5 - 17.5 mm; stretchable 5 - 5.2 mm; plain; snap-on type; white



Item No.: 793-5501/000-002

WMB marking card; as card; for terminal block width 5 - 17.5 mm; stretchable 5 - 5.2 mm; plain; snap-on type; yellow



Item No.: 793-501/000-006

WMB marking card; as card; not stretchable; plain; snap-on type; blue



Item No.: 793-501/000-007

WMB marking card; as card; not stretchable; plain; snap-on type; gray



Item No.: 793-501/000-023

WMB marking card; as card; not stretchable; plain; snap-on type; green



Item No.: 793-501/000-017

WMB marking card; as card; not stretchable; plain; snap-on type; light green



Item No.: 793-501/000-012

WMB marking card; as card; not stretchable; plain; snap-on type; orange



Item No.: 793-501/000-005

WMB marking card; as card; not stretchable; plain; snap-on type; red



Item No.: 793-501/000-024

WMB marking card; as card; not stretchable; plain; snap-on type; violet



Item No.: 793-501

WMB marking card; as card; not stretchable; plain; snap-on type; white



Item No.: 793-501/000-002

WMB marking card; as card; not stretchable; plain; snap-on type; yellow



Item No.: 2009-115/000-006

WMB-Inline; for Smart Printer; 1500 pieces on roll; stretchable 5 - 5.2 mm; plain; snap-on type; blue



Item No.: 2009-115/000-007

WMB-Inline; for Smart Printer; 1500 pieces on roll; stretchable 5 - 5.2 mm; plain; snap-on type; gray



Item No.: 2009-115/000-023

WMB-Inline; for Smart Printer; 1500 pieces on roll; stretchable 5 - 5.2 mm; plain; snap-on type; green



Item No.: 2009-115/000-017

WMB-Inline; for Smart Printer; 1500 pieces on roll; stretchable 5 - 5.2 mm; plain; snap-on type; light green



Item No.: 2009-115/000-012

WMB-Inline; for Smart Printer; 1500 pieces on roll; stretchable 5 - 5.2 mm; plain; snap-on type; orange

1.1.7.2 Marker



Item No.: 2009-115/000-005

WMB-Inline; for Smart Printer; 1500 pieces on roll; stretchable 5 - 5.2 mm; plain; snap-on type; red



Item No.: 2009-115/000-024

WMB-Inline; for Smart Printer; 1500 pieces on roll; stretchable 5 - 5.2 mm; plain; snap-on type; violet



Item No.: 2009-115

WMB-Inline; for Smart Printer; 1500 pieces on roll; stretchable 5 - 5.2 mm; plain; snap-on type; white



Item No.: 2009-115/000-002

WMB-Inline; for Smart Printer; 1500 pieces on roll; stretchable 5 - 5.2 mm; plain; snap-on type; yellow

1.1.7.3 Marker carrier



Item No.: 285-442

Adaptor; gray

1.1.8 Power tap

1.1.8.1 Power tap



Item No.: 285-407

Power tap; for 95 mm² high-current tbs; gray

1.1.9 Protective warning marker

1.1.9.1 Cover



Item No.: 285-170

Protective warning marker; with high-voltage symbol, black; yellow



Item No.: 285-175

Protective warning marker; yellow

1.1.10 Tool

1.1.10.1 Operating tool



Item No.: 285-172

Allen wrench; with a partially insulated shaft; green



Item No.: 285-173

Allen wrench; with a partially insulated shaft; with anti-rotation protection; green

Installation Notes

Installation

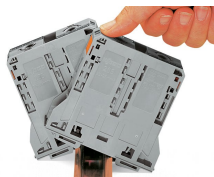

Snapping a terminal block onto DIN-rail (to the left or to the right).

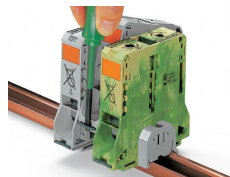

Removing a terminal block from the assembly (to the left or to the right).

Conductor termination



For the optimal clamping force:

- Bend conductor
- Cut conductor to length (conductor end must be straight)
- Strip conductor



Always observe the on-unit printed strip length guide!

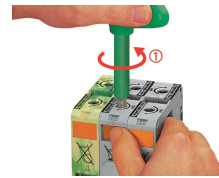

Conductor termination – step 1:
Rotate the T-wrench counter-clockwise to the stop. Next, push in the orange locking tab. The clamp is locked open for hands-free wiring.

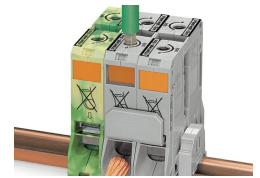

Conductor termination – step 2:
Insert a stripped conductor into the clamping unit until it hits the backstop. Hold in this position.

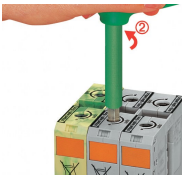

Conductor termination – step 3:
A short counter-clockwise rotation releases the tab. When unlocked, the T-wrench rotates clockwise, securely clamping the conductor.

Commoning

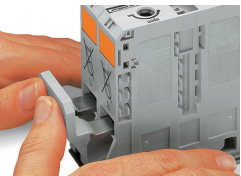

Commoning with an adjacent jumper: insert the jumper above the conductor entry hole – prior to conductor termination. The nominal cross-section remains unchanged.

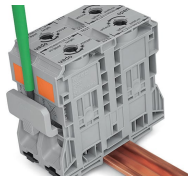

Removing jumper via operating tool.

Cover



Protective warning marker may indicate: Notice: Power is still on even after switching off the main switch!



Yellow, detachable finger guards provide touch-proof safety by shielding jumper contact slots and/or unused conductor entries.

Power tap



Easily and consistently tap directly into the power supply. Insert the unwired tap before opening the clamping unit.

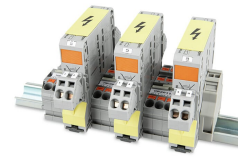

The power taps enable the distribution of the L1, L2 and L3 potentials. The warning covers and finger guards ensure IP20 touch-proof protection.

Current and voltage tap



Installation via jumper slot



Feedthrough for primary conductors



Push-in CAGE CLAMP® connection technology



Integrated fuse

Security

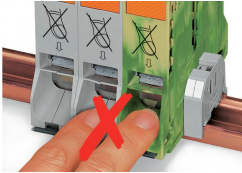

Risk of Injury!
Do not insert fingers in the conductor entry!

Testing



Testing via touch-proof 4 mm Ø test plugs (not available from WAGO, but offered by industry suppliers such as, Multi-Contact Deutschland GmbH).

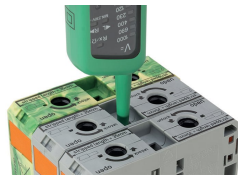

Testing
Voltage measurements can be performed, e.g., using a 2-pole voltage tester (Item No. 206-707).

Marking

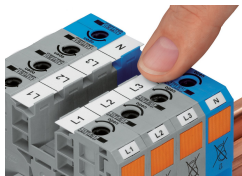

WMB markers or self-adhesive, printable marking strips can be accommodated on 35, 50 and 95 mm² high-current terminal blocks.

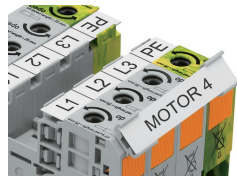

Marker carrier (Item No. 285-442) for marking strips (Item No. 2009-110) or 2 WMB markers for 285-13x, 285-15x and 285-19x Terminal Blocks