

# HC-M-12-PT-M - Contact insert module



1424246

<https://www.phoenixcontact.com/gb/products/1424246>

Please be informed that the data shown in this PDF document is generated from our online catalog. Please find the complete data in the user documentation. Our general terms of use for downloads are valid.



Contact insert module, number of positions: 12, power contacts: 0, control contacts: 12, Pin, Push-in connection, 250 V, 10 A, 0.14 mm<sup>2</sup> ... 1.5 mm<sup>2</sup>, application: Signal

## Your advantages

- Easy installation without tools, even when mounted, with push-in connection technology
- Shortest installation time compared to other connection technologies
- Quick and effortless wiring, in particular when space is tight
- Automatic cabling with robots possible
- Safe wiring and operation with color-coded actuators
- Shock and vibration-resistant in accordance with DIN EN 61373

## Commercial data

Item number	1424246
Packing unit	1 pc
Minimum order quantity	1 pc
Sales key	BF7ACE
Product key	BF7ACE
Catalog page	Page 577 (C-2-2019)
GTIN	4055626369600
Weight per piece (including packing)	22.133 g
Weight per piece (excluding packing)	21 g
Customs tariff number	85366990
Country of origin	PL

# HC-M-12-PT-M - Contact insert module



1424246

<https://www.phoenixcontact.com/gb/products/1424246>

## Technical data

### Notes

General	only use flexible conductors with ferrules
General	Connectors may be operated only when there is no load/voltage.
General	For HEAVYCON housing type B6 to B48, HC-M-B...MF-... hinged module carrier frame required.

### Mounting

Assembly instructions	To ensure correct use, installation in housing with IP54 protection or better is required
-----------------------	---

### Product properties

Product type	Modular contact insert
Number of positions	12
Connection profile	12
Contact numbering	1 - 12
Application	Signal
Number of module slots	1
No. of power contacts	0
No. of control contacts	12
Contact material type	turned
Series	HC-M-12

### Insulation characteristics

Overvoltage category	III
Degree of pollution	3

### Connection data

#### Connection technology

Connection technology	Push-in connection
-----------------------	--------------------

#### Conductor connection

Conductor cross section	0.14 mm <sup>2</sup> ... 1.5 mm <sup>2</sup>
Connection cross section AWG	26 ... 16
Stripping length of the individual wire	8 mm

### Dimensions

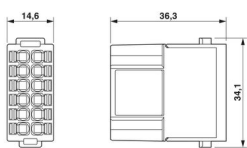
Dimensional drawing	
Width	34.1 mm

# HC-M-12-PT-M - Contact insert module



1424246

<https://www.phoenixcontact.com/gb/products/1424246>

Height	36.3 mm
Length	14.6 mm

## Mechanical characteristics

Contact diameter	1.6 mm
------------------	--------

## Electrical properties

Rated voltage (III/2) contacts	400 V
Rated voltage (III/3)	250 V
Rated surge voltage (III/2)	4 kV
Rated surge voltage (III/3)	4 kV
Rated surge voltage	4 kV
Rated current	10 A

## Mechanical properties

### Mechanical data

Insertion/withdrawal cycles	≥ 500
-----------------------------	-------

## Material specifications

Flammability rating according to UL 94	V0
Contact material	Copper alloy
Contact surface material	Ag
Contact carrier material	PC
Standards/regulations	PC: Fire protection in rail vehicles - requirement sets R22, R23, and R24 acc. to DIN EN 45545-2 (Risk level HL1 - HL3)

## Environmental and real-life conditions

### Ambient conditions

Ambient temperature (operation)	-40 °C ... 125 °C
---------------------------------	-------------------

## Standards and regulations

### Testing

Standards/regulations	PC: Fire protection in rail vehicles - requirement sets R22, R23, and R24 acc. to DIN EN 45545-2 (Risk level HL1 - HL3)
-----------------------	---

# HC-M-12-PT-M - Contact insert module

1424246

<https://www.phoenixcontact.com/gb/products/1424246>



## Drawings

Schematic diagram

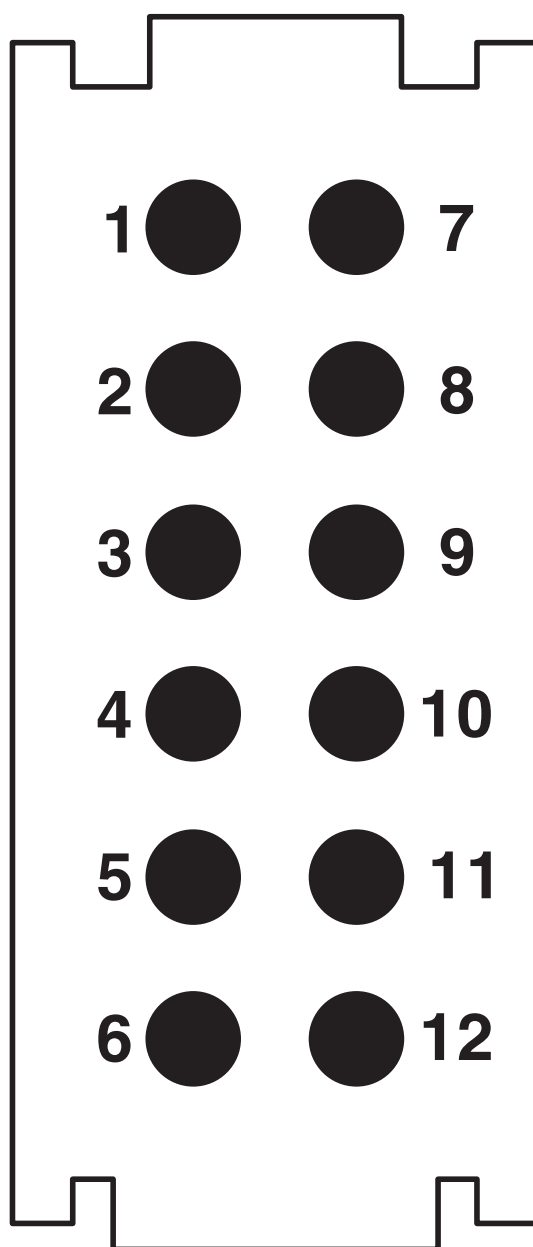

Connector pin assignment, connection side

# HC-M-12-PT-M - Contact insert module

1424246

<https://www.phoenixcontact.com/gb/products/1424246>

Dimensional drawing

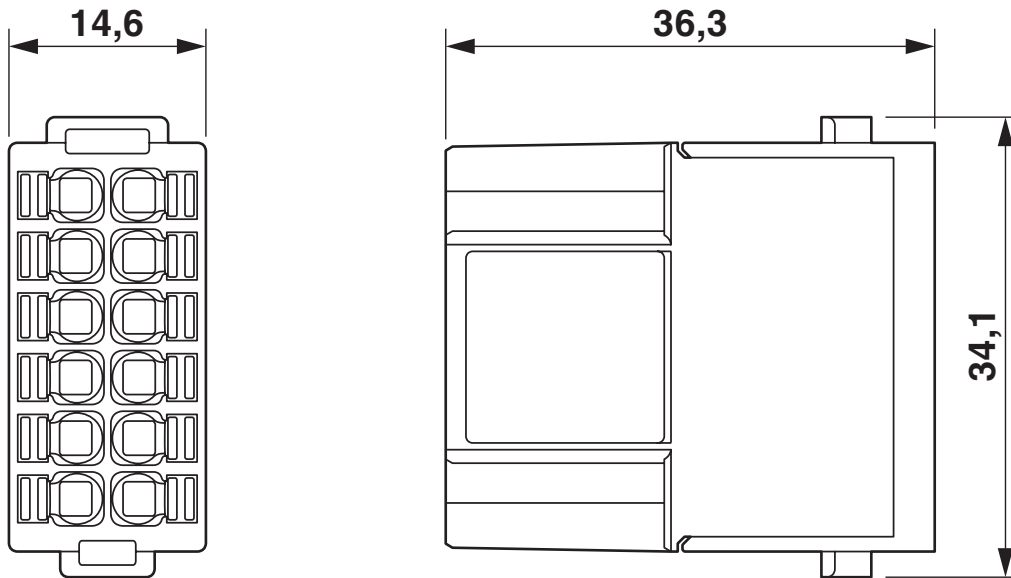

Dimensional drawing

Diagram

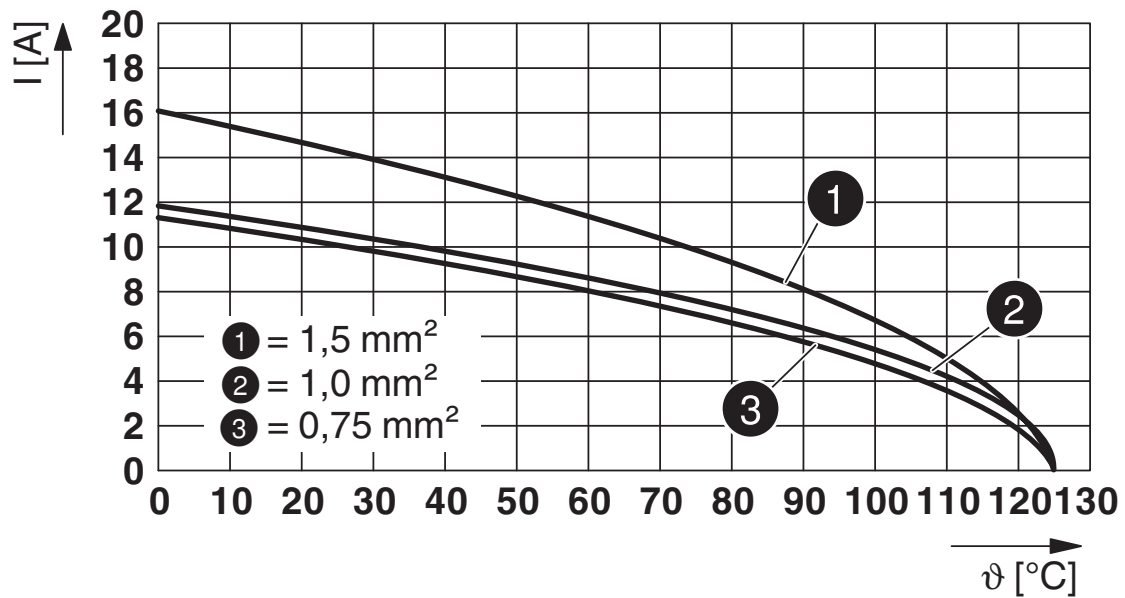

Derating diagram

# HC-M-12-PT-M - Contact insert module





1424246

<https://www.phoenixcontact.com/gb/products/1424246>

## Approvals

To download certificates, visit the product detail page: <https://www.phoenixcontact.com/gb/products/1424246>

 <b>UL Recognized</b> Approval ID: E118976				
	Nominal voltage $U_N$	Nominal current $I_N$	Cross section AWG	Cross section $\text{mm}^2$
	600 V	10 A	- 16	-

 <b>EAC</b> Approval ID: RU C-DE.BL08.B.00511				
---	--	--	--	--

 <b>UL Recognized</b> Approval ID: E468743				
	Nominal voltage $U_N$	Nominal current $I_N$	Cross section AWG	Cross section $\text{mm}^2$
	600 V	10 A	-	-

# HC-M-12-PT-M - Contact insert module



1424246

<https://www.phoenixcontact.com/gb/products/1424246>

## Classifications

### ECLASS

ECLASS-11.0	27440217
ECLASS-12.0	27440217
ECLASS-13.0	27440217

### ETIM

ETIM 9.0	EC000438
----------	----------

### UNSPSC

UNSPSC 21.0	39121400
-------------	----------

# HC-M-12-PT-M - Contact insert module



1424246

<https://www.phoenixcontact.com/gb/products/1424246>

## Environmental product compliance

China RoHS	Environmentally friendly use period: unlimited = EFUP-e
	No hazardous substances above threshold values

# HC-M-12-PT-M - Contact insert module

1424246

<https://www.phoenixcontact.com/gb/products/1424246>



## Accessories

### HC-CBU-MOD - Coding element

1636130

<https://www.phoenixcontact.com/gb/products/1636130>



Coding socket for coding up to 16 connectors, for HC Modular

---

### HC-CST-MOD - Coding element

1636127

<https://www.phoenixcontact.com/gb/products/1636127>



Coding peg for coding up to 16 connectors, for HC Modular

# HC-M-12-PT-M - Contact insert module

1424246

<https://www.phoenixcontact.com/gb/products/1424246>



## HC-M-B06-MFH-B - Module carrier frame

1182085

<https://www.phoenixcontact.com/gb/products/1182085>



Module carrier frame, size: B6, type : for the panel mounting side (a, b, c, ...), 4 mm<sup>2</sup> ... 6 mm<sup>2</sup>, application: Module carrier frame

---

## HC-M-B10-MFH-B - Module carrier frame

1182088

<https://www.phoenixcontact.com/gb/products/1182088>

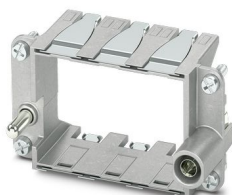

Module carrier frame, size: B10, type : for the panel mounting side (a, b, c, ...), 4 mm<sup>2</sup> ... 6 mm<sup>2</sup>, application: Module carrier frame

# HC-M-12-PT-M - Contact insert module

1424246

<https://www.phoenixcontact.com/gb/products/1424246>



## HC-M-B16-MFH-B - Module carrier frame

1182090

<https://www.phoenixcontact.com/gb/products/1182090>

Module carrier frame, size: B16, type : for the panel mounting side (a, b, c, ...), 4 mm<sup>2</sup> ... 6 mm<sup>2</sup>, application: Module carrier frame



---

## HC-M-B24-MFH-B - Module carrier frame

1182094

<https://www.phoenixcontact.com/gb/products/1182094>

Module carrier frame, size: B24, type : for the panel mounting side (a, b, c, ...), 4 mm<sup>2</sup> ... 6 mm<sup>2</sup>, application: Module carrier frame



# HC-M-12-PT-M - Contact insert module

1424246

<https://www.phoenixcontact.com/gb/products/1424246>



## HC-M-B06-MFH-H - Module carrier frame

1182087

<https://www.phoenixcontact.com/gb/products/1182087>



Module carrier frame, size: B6, type : for the sleeve side (A, B, C, ...), 4 mm<sup>2</sup> ... 6 mm<sup>2</sup>, application: Module carrier frame

---

## HC-M-B10-MFH-H - Module carrier frame

1182089

<https://www.phoenixcontact.com/gb/products/1182089>



Module carrier frame, size: B10, type : for the sleeve side (A, B, C, ...), 4 mm<sup>2</sup> ... 6 mm<sup>2</sup>, application: Module carrier frame

# HC-M-12-PT-M - Contact insert module

1424246

<https://www.phoenixcontact.com/gb/products/1424246>



## HC-M-B16-MFH-H - Module carrier frame

1182093

<https://www.phoenixcontact.com/gb/products/1182093>

Module carrier frame, size: B16, type : for the sleeve side (A, B, C, ...), 4 mm<sup>2</sup> ...  
6 mm<sup>2</sup>, application: Module carrier frame



---

## HC-M-B24-MFH-H - Module carrier frame

1182095

<https://www.phoenixcontact.com/gb/products/1182095>

Module carrier frame, size: B24, type : for the sleeve side (A, B, C, ...), 4 mm<sup>2</sup> ...  
6 mm<sup>2</sup>, application: Module carrier frame



## HC-M-12-PT-M - Contact insert module

1424246

<https://www.phoenixcontact.com/gb/products/1424246>



## HC-M-12-PT-F - Contact insert module

1424228

<https://www.phoenixcontact.com/gb/products/1424228>



Contact insert module, number of positions: 12, power contacts: 0, control contacts: 12, Socket, Push-in connection, 250 V, 10 A, 0.14 mm<sup>2</sup> ... 1.5 mm<sup>2</sup>, application: Signal

---

## CF CRIMPHANDY 0,5 - Electrical crimping tool

1212463

<https://www.phoenixcontact.com/gb/products/1212463>



Mobile handheld device, battery-powered, for processing on-tape ferrules 0.5 mm<sup>2</sup> with functional end, suitable for PVC insulated conductors (H05V-K), incl. battery, charger, CUTFOX 12 cable cutter, waste guide plate 2, service tool for error correction, and one strip of ferrules 0.5 mm<sup>2</sup>, packed in a robust case.

# HC-M-12-PT-M - Contact insert module

1424246

<https://www.phoenixcontact.com/gb/products/1424246>



## CF CRIMPHANDY 0,75 - Electrical crimping tool

1212464

<https://www.phoenixcontact.com/gb/products/1212464>



Mobile handheld device, battery-powered, for processing on-tape ferrules 0.75 mm<sup>2</sup> with functional end, suitable for PVC insulated conductors (H05V-K), incl. battery, charger, CUTFOX 12 cable cutter, waste guide plate 2, service tool for error correction, and one strip of ferrules 0.75 mm<sup>2</sup>, packed in a robust case.

---

## CF CRIMPHANDY 1,0 - Electrical crimping tool

1212465

<https://www.phoenixcontact.com/gb/products/1212465>



Mobile handheld device, battery-powered, for processing on-tape ferrules 1.0 mm<sup>2</sup> with functional end, suitable for PVC insulated conductors (H05V-K), incl. battery, charger, CUTFOX 12 cable cutter, waste guide plate 2, service tool for error correction, and one strip of ferrules 1.0 mm<sup>2</sup>, packed in a robust case.

# HC-M-12-PT-M - Contact insert module

1424246

<https://www.phoenixcontact.com/gb/products/1424246>



## CF CRIMPHANDY 1,5 - Electrical crimping tool

1212466

<https://www.phoenixcontact.com/gb/products/1212466>



Mobile handheld device, battery-powered, for processing on-tape ferrules 1.5 mm<sup>2</sup> with functional end, suitable for PVC insulated conductors (H07V-K), incl. battery, charger, CUTFOX 12 cable cutter, waste guide plate 2, service tool for error correction, and one strip of ferrules 1.5 mm<sup>2</sup>, packed in a robust case.

---

Phoenix Contact 2024 © - all rights reserved

<https://www.phoenixcontact.com>

PHOENIX CONTACT Ltd

Halesfield 13, Telford

Shropshire, TF7 4PG

01952 681700

[info@phoenixcontact.co.uk](mailto:info@phoenixcontact.co.uk)