

DATASHEET

CATEGORY: APLIWELD specific mould
 NAME: **Parallel horizontal cable/cable mould**
 REFERENCE: **C35/C35/PH**

PRODUCT DESCRIPTION

Mould for 35 mm² cable with 35 mm² cable, parallel horizontal connection.

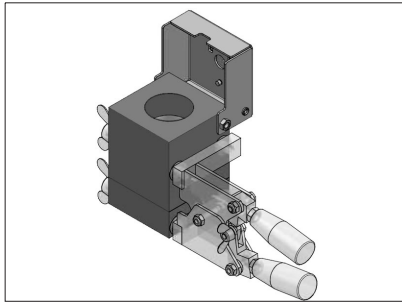

> Union

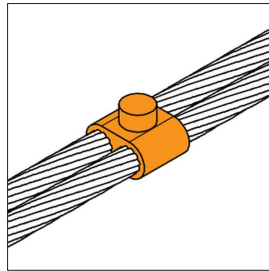

DATASHEET

Reference	C35/C35/PH
Length	80 mm
Width	80 mm
Height	110 mm
Diameter of the whole	D1 = 7.5 mm D2 = 7.5 mm
Weight	1385 g
Material/s	Graphite with electrogalvanised steel cover
Duration (nr. of weldings)	70
Conductor 1	35 mm ² cable
Conductor 2	35 mm ² cable
Tablets for Apliweld-T exothermic welding	AT-020N
Number of tablets per connection	2
Closing clamp	AT-049N
Starters for electronic ignition	AT-010N
Electronic starting device	AT-100N
Starting powder for manual ignition	AT-012N
Spark lighter for manual ignition	AT-060N

Basic accessories kit	AT-069N
Standards	Complies with UNE 21186, NF C 17-102, IEC 62305

> TESTS AND CERTIFICATIONS

UL Certificate according to UL 467 (E354045)

INSTRUCTIONS

> SAFETY AND MAINTENANCE

Read carefully the particular product instructions supplied in all APLIWELD® products before its use.

All personnel that will carry out APLIWELD® exothermic welding should be duly trained in the correct usage of the product.

OTHER INFORMATION

> ACCESSORIES



AT-020N
Apliweld-T: Welding tablets (20u)



AT-049N
Model S clamp for specific moulds



AT-010N
Apliweld-E: Electronic starter (10ud)



AT-069N
Basic tool set Apliweld-E



AT-100N
Kit Apliweld-E: Ignition kit