







IS 2360 ECO 7m

white
 EAN 4007841 006556
 Article number 006556



		2000 W					5 years	
infrared sensor 360°	max. 7 m	2000 W max. (LED-ready)	IP54	2 - 2000 lux	8 sec - 35 min	energy saving	manufacturer's warranty steinel-professional.de/garantie	CE

Function description

Elegant. Compact. Inconspicuous. IS 2360 ECO precision infrared surface-mounted sensor. Ideal for porches and small rooms. 360° angle of coverage, 160° angle of aperture and 7 m reach. Passive infrared sensor technology. Easy to install. Finish colour: white.

Technical specifications

Dimensions (Ø x H)	115 x 51 mm	LED lamps > 2 W < 8 W	64 W
Manufacturer's Warranty	5 years	LED lamps > 8 W	64 W
Settings via	Potentiometers	Capacitive load in µF	132 µF
With remote control	No	Technology, sensors	passive infrared, Light sensor
Version	white	Mounting height	2,00 – 4,00 m
PU1, EAN	4007841006556	Mounting height max.	4,00 m
Type	Motion detectors	Optimum mounting height	2,8 m
Application, place	Outdoors, Indoors	Detection angle	360 °
Application, room	corridor / aisle, changing room, function room / ancillary room, kitchenette, stairwell, WC / washroom, multi-storey / underground car park, outdoors, warehouse, Indoors	Angle of aperture	180 °
Colour	white	Sneak-by guard	Yes
Colour, RAL	9010	Capability of masking out individual segments	Yes
Includes corner wall mount	No	Electronic scalability	No
Installation site	ceiling	Mechanical scalability	No
Installation	Surface wiring, Ceiling	Reach, radial	Ø 3 m (7 m ²)
		Reach, tangential	Ø 7 m (38 m ²)
		Switching zones	664 switching zones
		Twilight setting	2 – 2000 lx

IS 2360 ECO 7m

white
EAN 4007841 006556
Article number 006556



Technical specifications

IP-rating	IP54
Ambient temperature	-20 – 50 °C
Material	Plastic
Mains power supply	230 V / 50 – 60 Hz
Switching output 1, resistive	2000 W
Switching output 1, number of LEDs / fluorescent lamps	6 pcs.
Fluorescent lamps, electronic ballast	1500 W
Fluorescent lamps, uncorrected	500 VA
Fluorescent lamps, series-corrected	500 VA
Fluorescent lamps, parallel-corrected	500 VA
Switching output 1, low-voltage halogen lamps	1000 VA
LED lamps < 2 W	16 W

Time setting	8 s – 35 Min.
Basic light level function	No
Main light adjustable	No
Twilight setting TEACH	No
Constant-lighting control	No
Interconnection	Yes
Type of interconnection	Master/master
Interconnection via	Cable

IS 2360 ECO 7m

white
EAN 4007841 006556
Article number 006556

Detection Zone

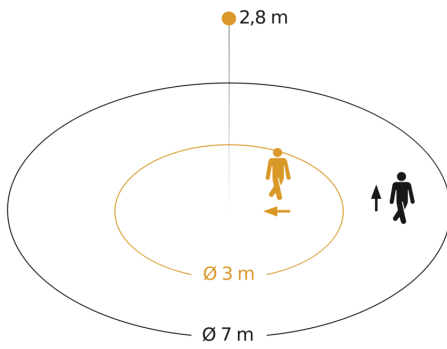

Possible mounting height: 2,00 m - 4,00 m
Orange: radial
Black: tangential

Dimension Drawing

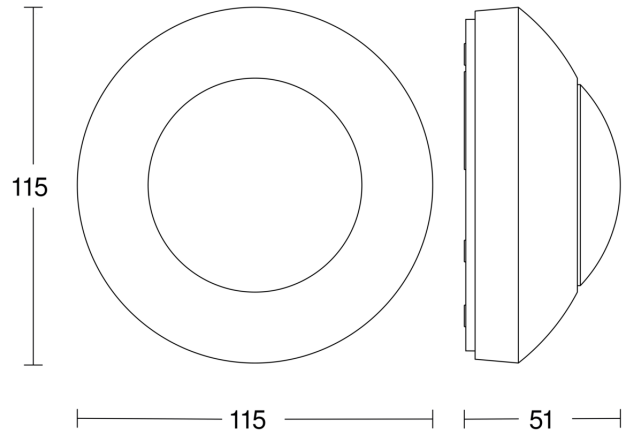

Circuit diagram

