

71560030001

STNL C4 THR INS TP302 M3X6

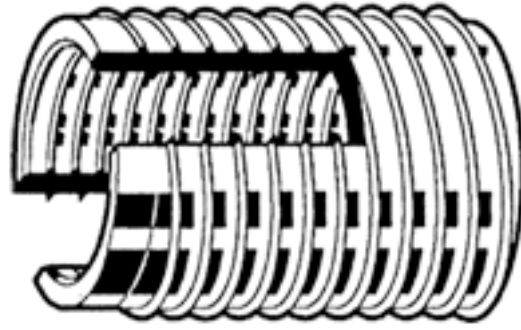

Brand	-
UBB Code	950355788221
UNSPSC Code	31162802
EAN Code	8715492910196
Type	302
Thread	Metric thread
Material	Stainless steel
Material technical	C4

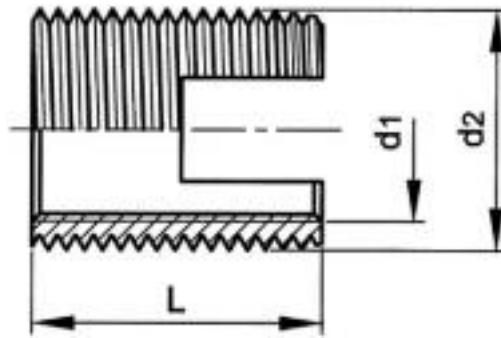

Drill depth (min.)	8
P (d2)	0,5
d2	5
P (d1)	0,5
L	6
d	M3
Packaging (Piece)	25.0



Copyright Fabory Group