

55660055013

D7981CH STNL A4 PAN TAPSCR PH ST5,5X13MM

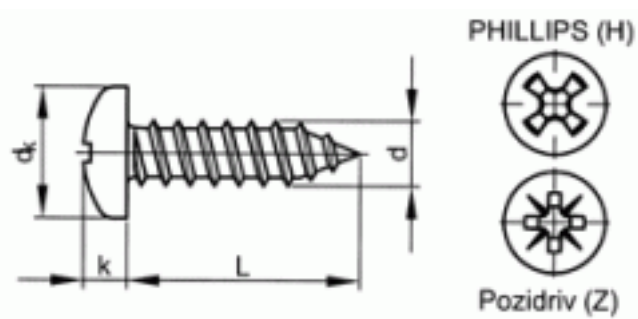

Brand	-
UBB Code	950352563049
UNSPSC Code	31161507
EAN Code	8715492350725
Head shape	pan head
Thread	Self tapping thread
Material	Stainless steel
Material technical	A4
Driving features	Phillips
DIN	7981 C



L	13
d	5,5
Packaging (Piece)	200.0



Copyright Fabory Group