

55660048013

D7981CH STNL A4 PAN TAPSCR PH ST4,8X13MM

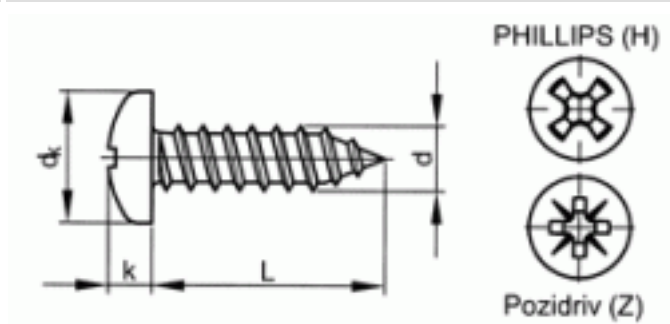

Brand	-
UBB Code	950352562132
UNSPSC Code	31161507
EAN Code	8715492350640
Head shape	pan head
Thread	Self tapping thread
Material	Stainless steel
Material technical	A4
Driving features	Phillips
DIN	7981 C



L	13
d	4,8
Packaging (Piece)	200.0



Copyright Fabory Group