

55660035016

D7981CH STNL A4 PAN TAPSCR PH ST3,5X16MM

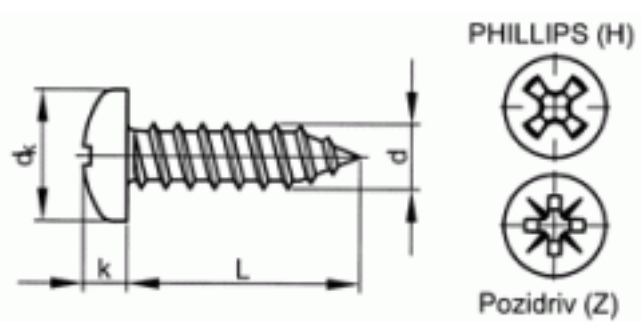

Brand	-
UBB Code	950352560235
UNSPSC Code	31161507
EAN Code	8715492350459
Head shape	pan head
Thread	Self tapping thread
Material	Stainless steel
Material technical	A4
Driving features	Phillips
DIN	7981 C



L	16
d	3,5
Packaging (Piece)	200.0



Copyright Fabory Group