

55660029019

D7981CH STNL A4 PAN TAPSCR PH ST2,9X19MM

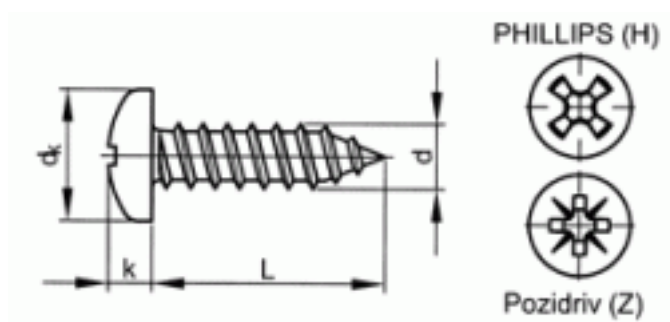

Brand	-
UBB Code	950352559831
UNSPSC Code	31161507
EAN Code	8715492350428
Head shape	pan head
Thread	Self tapping thread
Material	Stainless steel
Material technical	A4
Driving features	Phillips
DIN	7981 C



L	19
d	2,9
Packaging (Piece)	200.0



Copyright Fabory Group