

48170100016

D963 BRAS CSK SCR SLOTT M10X16

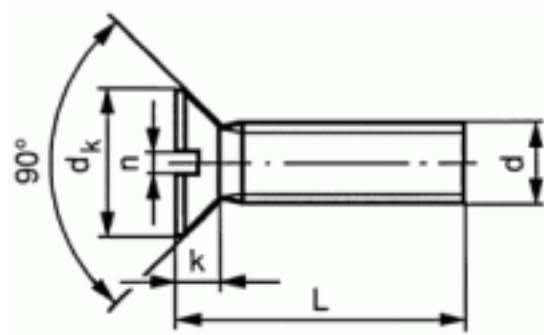

Brand	-
UBB Code	950353205897
UNSPSC Code	31161504
EAN Code	8715492849403
Thread	Metric thread
Material	Brass
Material technical	Cu2/Cu3
Driving features	slotted



Full thread L ≤	50
n	2,5
k (max.)	5
dk	18
P	1,5
L	16
d	M10
Packaging (Piece)	100.0



Copyright Fabory Group