

48170080020

D963 BRAS CSK SCR SLOTT M8X20

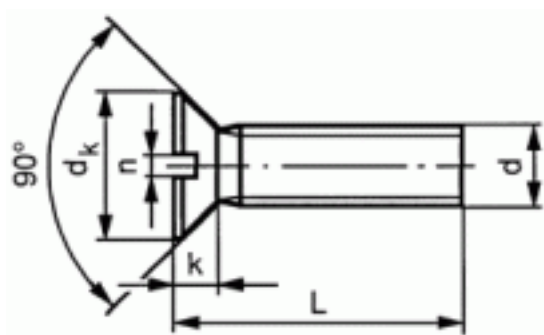

Brand	-
UBB Code	950353205145
UNSPSC Code	31161504
EAN Code	8715492849304
Thread	Metric thread
Material	Brass
Material technical	Cu2/Cu3
Driving features	slotted



Full thread L ≤	40
n	2
k (max.)	4
dk	14,5
P	1,25
L	20
d	M8
Packaging (Piece)	100.0



Copyright Fabory Group