

48170060050

D963 BRAS CSK SCR SLOTT M6X50

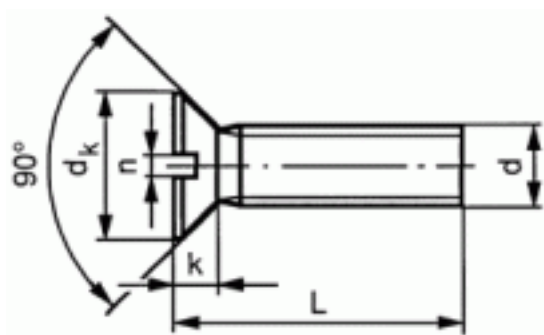

Brand	-
UBB Code	950353204809
UNSPSC Code	31161504
EAN Code	8715492849236
Thread	Metric thread
Material	Brass
Material technical	Cu2/Cu3
Driving features	slotted



Full thread L ≤	35
n	1,6
k (max.)	3
dk	11
P	1
L	50
d	M6
Packaging (Piece)	200.0



Copyright Fabory Group