

3722020001

D7980 HI-COLL ST ZPL RWA M20

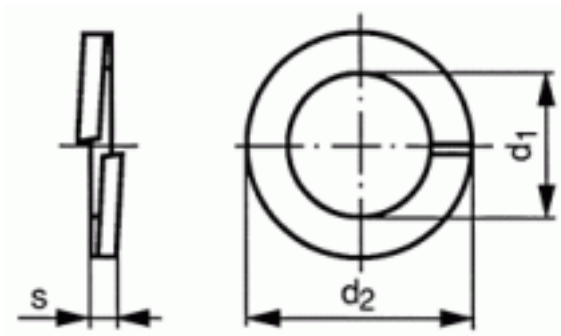

Brand	-
UBB Code	950357072079
UNSPSC Code	31161811
EAN Code	8715492767240
Surface treatment	Zinc plated
Material technical	DIN267-26
Material	Spring steel



s	4,5
d2 (max.)	30,6
d1 (min.)	20,2
For nom. size	M20
Packaging (Piece)	100.0



Copyright Fabory Group