

3722010001

D7980 HI-COLL ST ZPL RWA M10

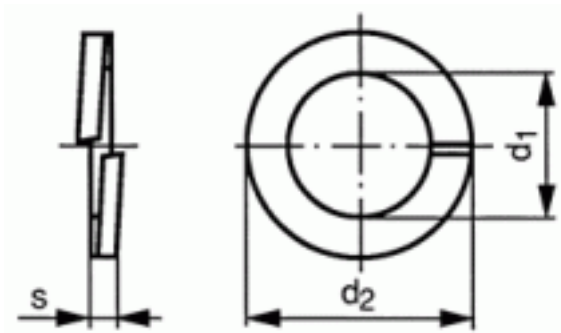

Brand	-
UBB Code	950357071659
UNSPSC Code	31161811
EAN Code	8715492767189
Surface treatment	Zinc plated
Material technical	DIN267-26
Material	Spring steel



s	2,5
d2 (max.)	16
d1 (min.)	10,2
For nom. size	M10
Packaging (Piece)	200.0



Copyright Fabory Group