

37220060001

D7980 HI-COLL ST ZPL RWA M6

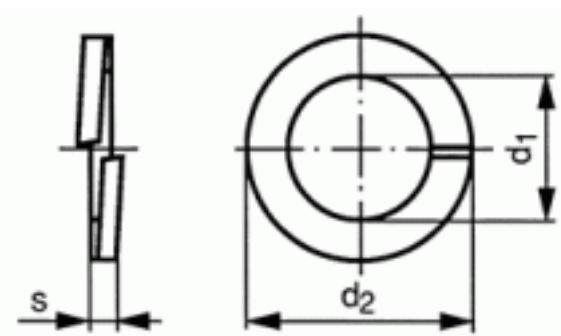

Brand	-
UBB Code	950357071402
UNSPSC Code	31161811
EAN Code	8715492767134
Surface treatment	Zinc plated
Material technical	DIN267-26
Material	Spring steel



s	1,6
d2 (max.)	9,9
d1 (min.)	6,1
For nom. size	M6
Packaging (Piece )	250.0



Copyright Fabory Group