

3707020001

~D128A ST YLP SPR WASH VSK M20

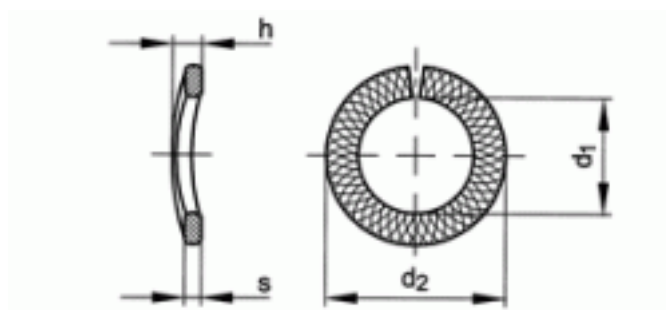

Brand	-
UBB Code	950357150446
UNSPSC Code	31161811
EAN Code	8715492765604
Surface treatment	Mechanical zinc plated yellow passivated
Material technical	DIN267-26
Material	Spring steel



For nom. size	M20
Packaging (Piece)	100.0



Copyright Fabory Group