

37020300001

D127B ST ZPL SPR WASH SP M30

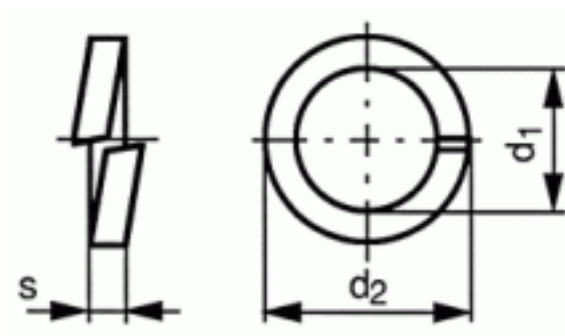

Brand	-
UBB Code	950357048657
UNSPSC Code	31161811
EAN Code	8715492764645
Surface treatment	Zinc plated
Material technical	DIN267-26
Material	Spring steel



s	6
d2 (max.)	48,2
d1 (min.)	30,5
For nom. size	M30
Packaging (Piece)	25.0



Copyright Fabory Group