

37020220001

D127B ST ZPL SPR WASH SP M22

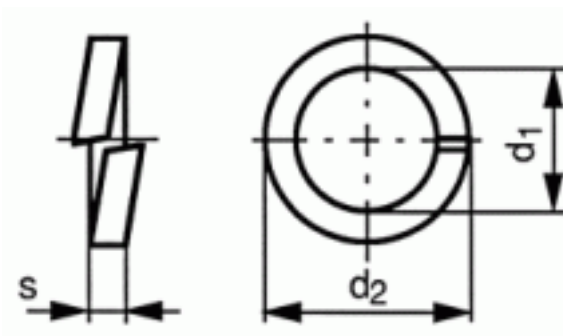

Brand	-
UBB Code	950357048244
UNSPSC Code	31161811
EAN Code	8715492764577
Surface treatment	Zinc plated
Material technical	DIN267-26
Material	Spring steel



s	4
d2 (max.)	35,9
d1 (min.)	22,5
For nom. size	M22
Packaging (Piece)	50.0



Copyright Fabory Group