

37020060001

D127B ST ZPL SPR WASH SP M6

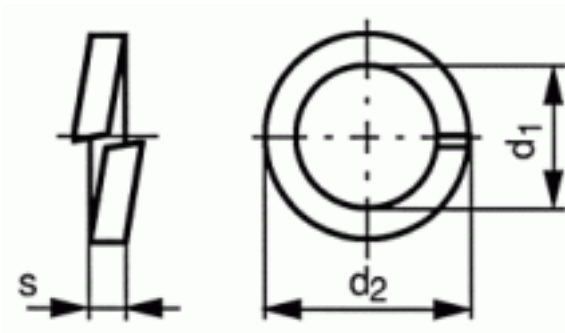

Brand	-
UBB Code	950357047097
UNSPSC Code	31161811
EAN Code	8715492764393
Surface treatment	Zinc plated
Material technical	DIN267-26
Material	Spring steel



s	1,6
d2 (max.)	11,8
d1 (min.)	6,1
For nom. size	M6
Packaging (Piece)	250.0



Copyright Fabory Group