

31820042025

ZPL PH SLF-DR PH ST4,2X25MM

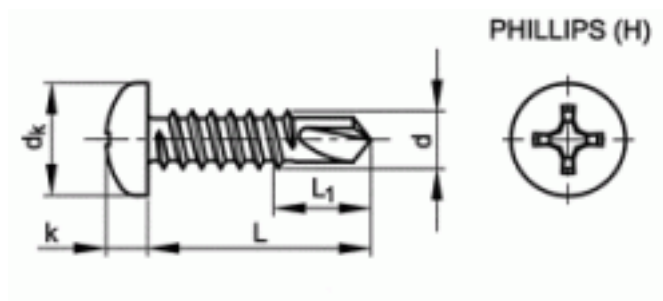

Brand	-
UBB Code	950352586495
UNSPSC Code	31161507
EAN Code	8715492965738
Driving features	Phillips
Head shape	pan head
Thread	Self tapping thread
Material	Steel
Surface treatment	Zinc plated



No. cross recess	2
L1 ≈	7
k	3,05
dk	8,2
P	1,4
L	25
d	4,2
Packaging (Piece)	2000.0



Copyright Fabory Group