

26660063038

D7981CH ZPL PNHD TAPSC PH SP ST6,3X38MM

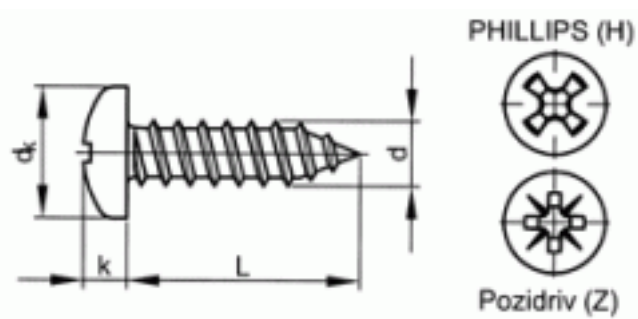

Brand	-
UBB Code	950352113415
UNSPSC Code	31161507
EAN Code	8715492944740
Head shape	pan head
Thread	Self tapping thread
Material	Steel
Surface treatment	Zinc plated
Driving features	Phillips
DIN	7981 C



L	38
d	6,3
Packaging (Piece)	100.0



Copyright Fabory Group