

26660063016

D7981CH ZPL PNHD TAPSC PH SP ST6,3X16MM

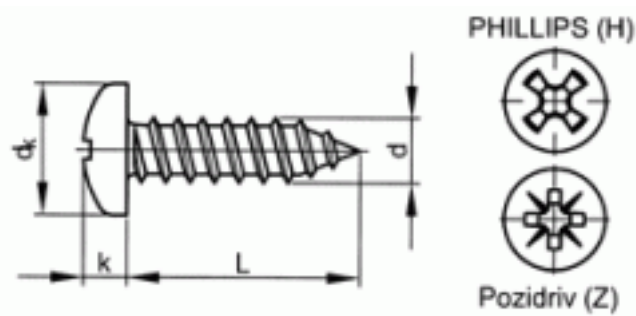

Brand	-
UBB Code	950352113092
UNSPSC Code	31161507
EAN Code	8715492944696
Head shape	pan head
Thread	Self tapping thread
Material	Steel
Surface treatment	Zinc plated
Driving features	Phillips
DIN	7981 C



L	16
d	6,3
Packaging (Piece )	100.0



Copyright Fabory Group