

26660055019

D7981CH ZPL PNHD TAPSC PH SP ST5,5X19MM

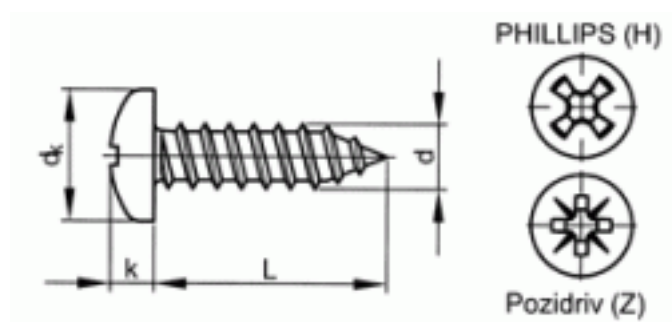

Brand	-
UBB Code	950352112342
UNSPSC Code	31161507
EAN Code	8715492944610
Head shape	pan head
Thread	Self tapping thread
Material	Steel
Surface treatment	Zinc plated
Driving features	Phillips
DIN	7981 C



L	19
d	5,5
Packaging (Piece )	200.0



Copyright Fabory Group