

26660055016

D7981CH ZPL PNHD TAPSC PH SP ST5,5X16MM

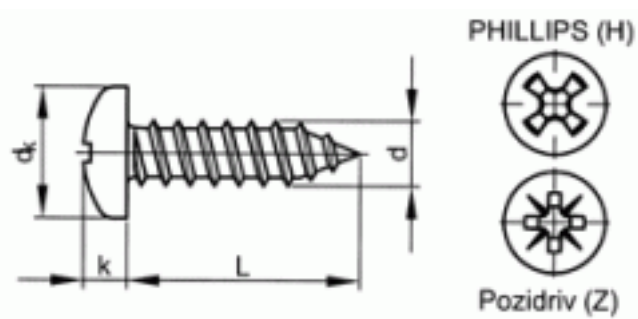

Brand	-
UBB Code	950352112268
UNSPSC Code	31161507
EAN Code	8715492944603
Head shape	pan head
Thread	Self tapping thread
Material	Steel
Surface treatment	Zinc plated
Driving features	Phillips
DIN	7981 C



L	16
d	5,5
Packaging (Piece)	200.0



Copyright Fabory Group