

26660048019

D7981CH ZPL PNHD TAPSC PH SP ST4,8X19MM

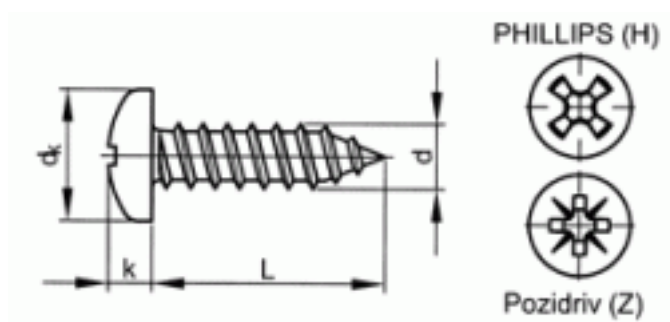

Brand	-
UBB Code	950352111500
UNSPSC Code	31161507
EAN Code	8715492944511
Head shape	pan head
Thread	Self tapping thread
Material	Steel
Surface treatment	Zinc plated
Driving features	Phillips
DIN	7981 C



L	19
d	4,8
Packaging (Piece )	200.0



Copyright Fabory Group