

26660042025

D7981CH ZPL PNHD TAPSC PH SP ST4,2X25MM

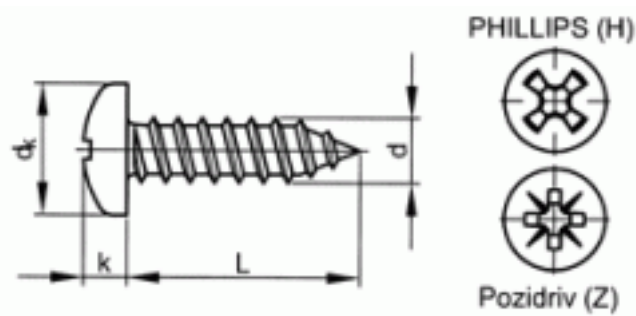

Brand	-
UBB Code	950352111013
UNSPSC Code	31161507
EAN Code	8715492944450
Head shape	pan head
Thread	Self tapping thread
Material	Steel
Surface treatment	Zinc plated
Driving features	Phillips
DIN	7981 C



L	25
d	4,2
Packaging (Piece )	200.0



Copyright Fabory Group