

26660042019

D7981CH ZPL PNHD TAPSC PH SP ST4,2X19MM

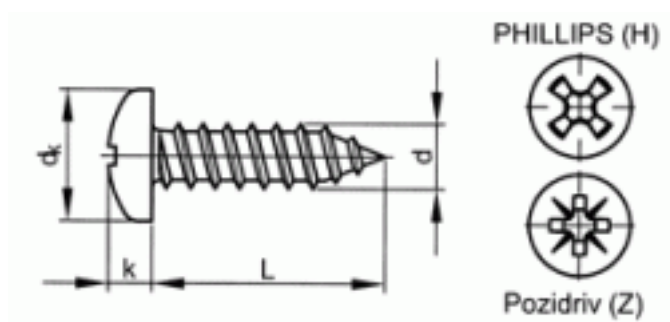

Brand	-
UBB Code	950352110932
UNSPSC Code	31161507
EAN Code	8715492944436
Head shape	pan head
Thread	Self tapping thread
Material	Steel
Surface treatment	Zinc plated
Driving features	Phillips
DIN	7981 C



L	19
d	4,2
Packaging (Piece)	200.0



Copyright Fabory Group