

26660039013

D7981CH ZPL PNHD TAPSC PH SP ST3,9X13MM

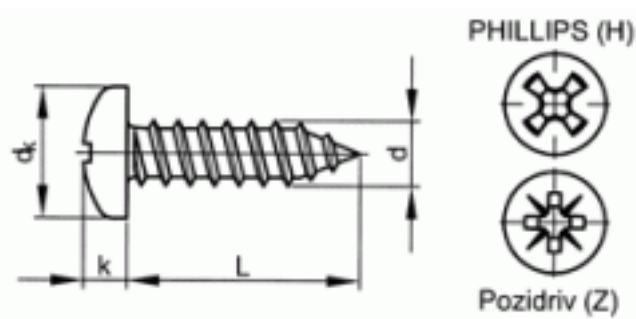

Brand	-
UBB Code	950352110288
UNSPSC Code	31161507
EAN Code	8715492944344
Head shape	pan head
Thread	Self tapping thread
Material	Steel
Surface treatment	Zinc plated
Driving features	Phillips
DIN	7981 C



L	13
d	3,9
Packaging (Piece )	200.0



Copyright Fabory Group