

26660029019

D7981CH ZPL PNHD TAPSC PH SP ST2,9X19MM

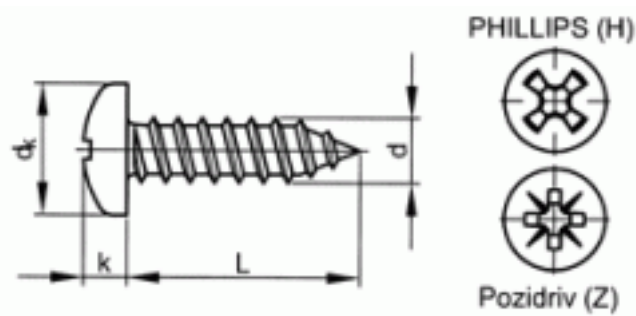

Brand	-
UBB Code	950352109132
UNSPSC Code	31161507
EAN Code	8715492944191
Head shape	pan head
Thread	Self tapping thread
Material	Steel
Surface treatment	Zinc plated
Driving features	Phillips
DIN	7981 C



L	19
d	2,9
Packaging (Piece)	200.0



Copyright Fabory Group