

26660063013

D7981CH ZPL PNHD TAPSC PH SP ST6,3X13MM

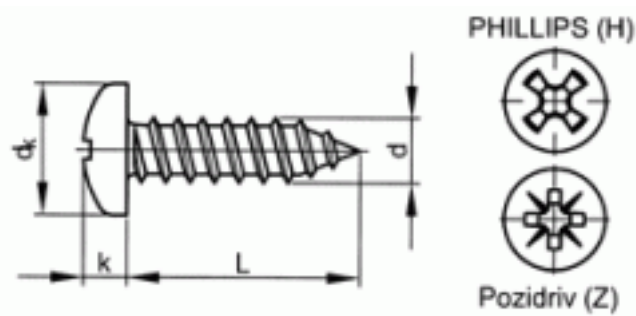

Brand	-
UBB Code	950352112912
UNSPSC Code	31161507
EAN Code	8715492944689
Head shape	pan head
Thread	Self tapping thread
Material	Steel
Surface treatment	Zinc plated
Driving features	Phillips
DIN	7981 C



L	13
d	6,3
Packaging (Piece)	100.0



Copyright Fabory Group