

24670060050

D965H 4.8 ZPL CSK SCR PH LP M6X50

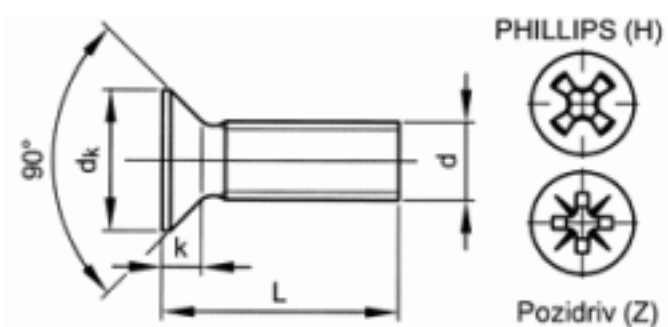

Brand	-
UBB Code	950353166370
UNSPSC Code	31161504
EAN Code	8715492641861
Thread	Metric thread
Class	4.8
Material	Steel
Surface treatment	Zinc plated
Driving features	Phillips



L	50
d	M6
Packaging (Piece)	250.0



Copyright Fabory Group