

12410240001

D985 |10| ZPL HX LCKNT/INS M24

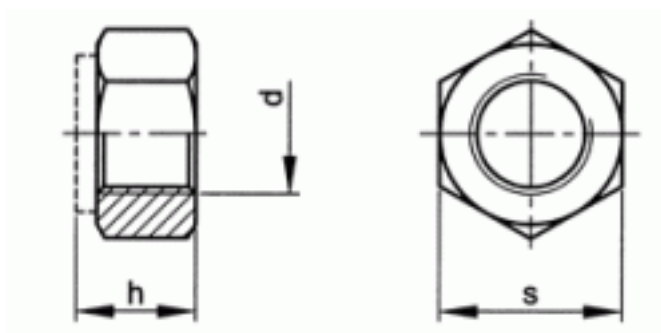

Brand	-
UBB Code	950355543360
UNSPSC Code	31161727
EAN Code	8715492578587
Driving features	hexagon
Thread	Metric thread
Class	10
Material	Steel
Surface treatment	Zinc plated



s	36
h	24
P	3
d	M24
Packaging (Piece)	25.0



Copyright Fabory Group