

12410200001

D985 |10| ZPL HX LCKNT/INS M20

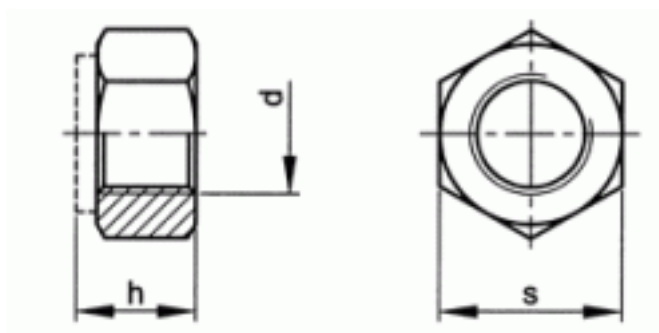

Brand	-
UBB Code	950355543287
UNSPSC Code	31161727
EAN Code	8715492578563
Driving features	hexagon
Thread	Metric thread
Class	10
Material	Steel
Surface treatment	Zinc plated



s	30
h	15
P	2,5
d	M20
Packaging (Piece)	25.0



Copyright Fabory Group