

12320300150

D985 |5| ZPL HX LCKNT/INS MF M30X1,50

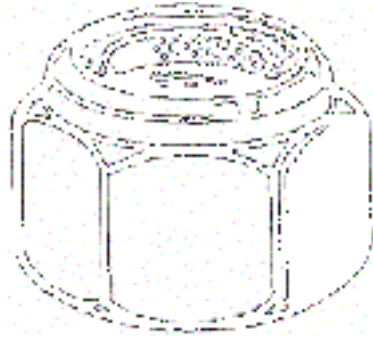

Brand	-
UBB Code	950355120862
UNSPSC Code	31161727
EAN Code	8715492577504
Head shape	hexagon head
Thread	Metric fine thread
Class	≥ 5
Material	Steel
Surface treatment	Zinc plated
Driving features	hexagon

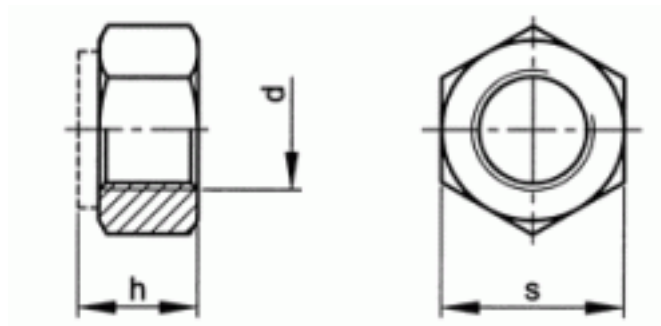

s	46
h	30
P	1,50
d	M30
Packaging (Piece)	10.0



Copyright Fabory Group