

12320140150

D985 |5| ZPL HX LCKNT/INS MF M14X1,50

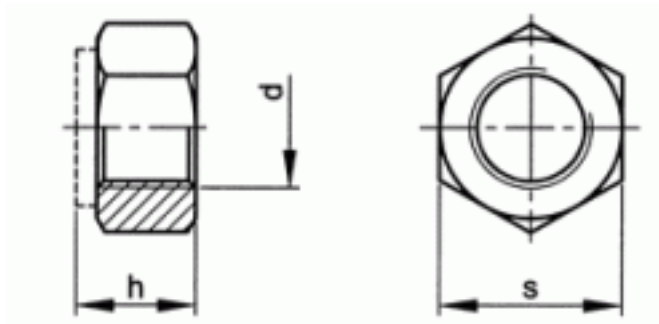

Brand	-
UBB Code	950355119971
UNSPSC Code	31161727
EAN Code	8715492577382
Head shape	hexagon head
Thread	Metric fine thread
Class	≥ 5
Material	Steel
Surface treatment	Zinc plated
Driving features	hexagon



s	22
h	14
P	1,50
d	M14
Packaging (Piece)	100.0



Copyright Fabory Group