

12320120125

D985 |5| ZPL HX LCKNT/INS MF M12X1,25

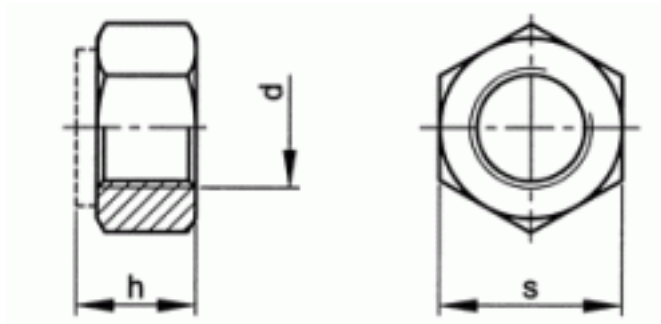

Brand	-
UBB Code	950355119716
UNSPSC Code	31161727
EAN Code	8715492577368
Head shape	hexagon head
Thread	Metric fine thread
Class	≥ 5
Material	Steel
Surface treatment	Zinc plated
Driving features	hexagon



s	19
h	12
P	1,25
d	M12
Packaging (Piece)	100.0



Copyright Fabory Group