

12320100125

D985 |5| ZPL HX LCKNT/INS MF M10X1,25

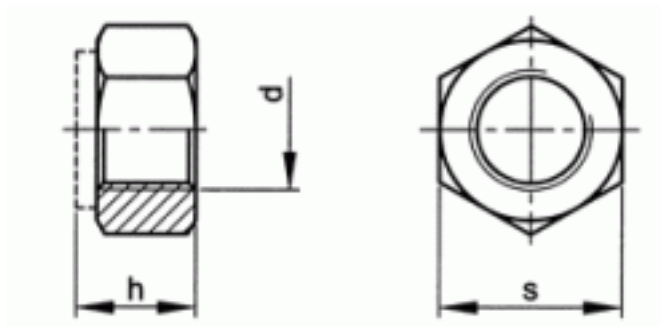

Brand	-
UBB Code	950355119559
UNSPSC Code	31161727
EAN Code	8715492577344
Head shape	hexagon head
Thread	Metric fine thread
Class	≥ 5
Material	Steel
Surface treatment	Zinc plated
Driving features	hexagon



s	17
h	10
P	1,25
d	M10
Packaging (Piece)	200.0



Copyright Fabory Group