

12300390001

D985 |5| ZPL HX LCKNT/INS SP M39

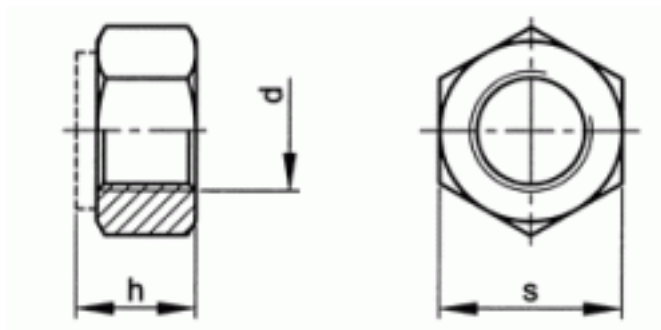

Brand	-
UBB Code	950355117322
UNSPSC Code	31161727
EAN Code	8715492576996
Driving features	hexagon
Thread	Metric thread
Class	≥ 5
Material	Steel
Surface treatment	Zinc plated



s	60
h	39
P	4
d	M39
Packaging (Piece)	5.0



Copyright Fabory Group