

12300330001

D985 |5| ZPL HX LCKNT/INS SP M33

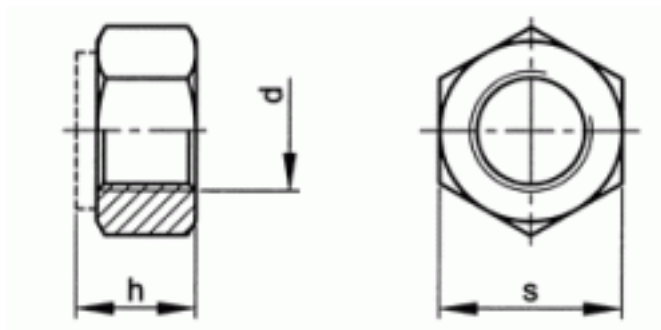

Brand	-
UBB Code	950355117165
UNSPSC Code	31161727
EAN Code	8715492576972
Driving features	hexagon
Thread	Metric thread
Class	≥ 5
Material	Steel
Surface treatment	Zinc plated



s	50
h	33
P	3,5
d	M33
Packaging (Piece )	5.0



Copyright Fabory Group