

12300240001

D985 |5| ZPL HX LCKNT/INS SP M24

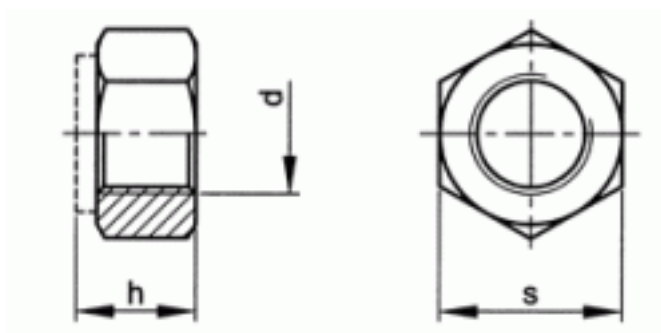

Brand	-
UBB Code	950355116829
UNSPSC Code	31161727
EAN Code	8715492576941
Driving features	hexagon
Thread	Metric thread
Class	≥ 5
Material	Steel
Surface treatment	Zinc plated



s	36
h	24
P	3
d	M24
Packaging (Piece)	25.0



Copyright Fabory Group