

**Description:**

Safety spindle drive to actuate vents and rooflights, for both smoke extraction and comfort ventilation

- housed in a round aluminium tube,
- maintenance free through permanent lubrication,
- outer parts corrosion-free,
- heat resistant silicone connection cable,
- sturdy construction.

The spindle actuator automatically switches off when it reaches its end positions due to the built-in electronic load switch-off.

**Diagram**

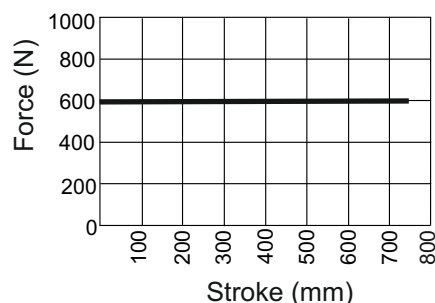

**Technical data:**

Item Description:	WMS 306
Operating Voltage:	24V DC (+30% -20%). Max.20% residual ripple
Max. current consumption:	1A
Max. force:	600N
Stroke:	300, 500, 750mm
Speed:	8mm/s (full load)
Switch-on duration:	max. 3 min per 10 min. (30%)
Load switch-off:	integrated electronic load switch-off
Protection type acc. to DIN VDE 0470 Part 1	IP 54
Temperature cond.:	-5°C to +75°C
Connection cable:	Silicone, grey, 2,5m
Housing:	Aluminium-tube, natural anodised, EV1
Note	We reserve the right to make technical changes

**Installation examples:**

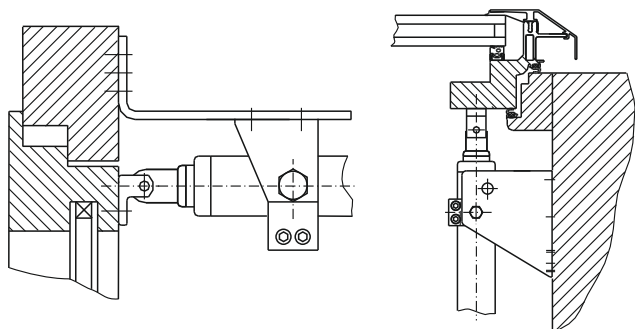

	Op	Cl	
white	+	-	Rated voltage 24V DC
brown	-	+	

**Note:**

Ensure that the actuator voltage coincides with that indicated on the type plate.  
Only permit fully trained qualified personnel to carry out installation and maintenance work.  
It must be ensured that all pertinent and valid regulations and guidelines are adhered to.  
The user/owner has to check and if necessary adapt all dimensional information on site.  
Check the electrical installation prior to starting up in accordance with the national safety regulations.

### Note:

Possible danger to persons caused by electric motor driven sash and frame.

The high forces occurring in the automatic mode can cause injury.

Actuators may extend into the room during opening, for this reason, care needs to be taken prior to starting up the actuators to exclude the risk of injury.

With vents tilting inwards or outwards, the vent must be protected from dropping down once the actuator is unhooked (e.g. for window cleaning).

For safety reasons we recommend the use of restrictors

In the event that vents or rooflights are subjected to high rain or wind loads, we recommend connecting the central control unit to a rain and wind sensor which will automatically close the vents.

### Installation:

The actuator can be installed in different ways. The criteria to be taken into account include the different pressure and pulling forces to be applied or the varying fitting situations on site.

The actuator can be installed at the actuator end using a clamping ring and corresponding brackets, or using an eyebolt.

Ensure that all fastening and clamping screws are properly tightened.

Settings and adjustments are made on site.

To position the actuator, without power, manually adjust the spindle rod by turning it to its end position, please be aware the spindle rod can run in a further 5mm when power is eventually applied.

If power is available, power the actuator to its end stop the position actuator to vent.

The electrical connection is to be made in accordance with the documentation for central control unit.

**Never** access the actuator without the corresponding motor electronics.

WSB 300 0010  
Pushrod bracket

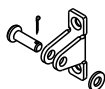

WSB 300 0011  
Pushrod bracket

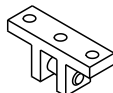

WSB 300 0012  
Pushrod bracket



### Start-up:

For the correct activation of 24V/DC safety actuators (for the technical safety function of the smoke extraction) it must be ensured that the smoke and heat extraction (SHE) central control unit functions are harmonized with the connected actuator units or that both form one system.

Only in this case can the safe function of the actuators or the overall control system be guaranteed.

Ensure that the actuator motors are powered in a voltage range of 19-32V / DC and at a maximum residual ripple of 20%.

The running direction of the actuators (OPEN/CLOSED) changes as the motor voltage polarity changes.

Ensure that a min. 0.5 s delay is allowed between the OPEN and CLOSED commands.

Only control the actuators in their self-locking mode. An activated CLOSED command must be followed by an OPEN command.

Avoid retriggering of actuators which are run in the load switch-off mode. This could cause damage to the actuators.

Ensure that the power supply to the central control unit on site is such that the start torque of the actuators can draw up to four times the overall power for a short period (min. 1 s) without the motor voltage dropping below 24V/DC.

WSB 300 0001  
Clampring + bracket

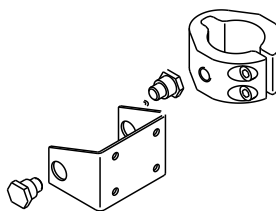

WSB 300 0002  
Clampring + bracket

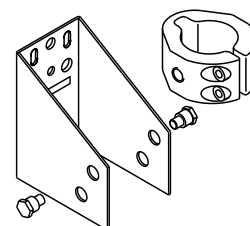

WSB 300 0004  
bottom eyebolt  
fastening

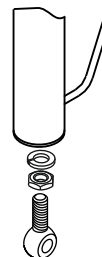

WSB 300 0003  
Clampring + bracket

