

08420080090

D603/555 4.6 HDG SQR NECK BLT OV M8X90

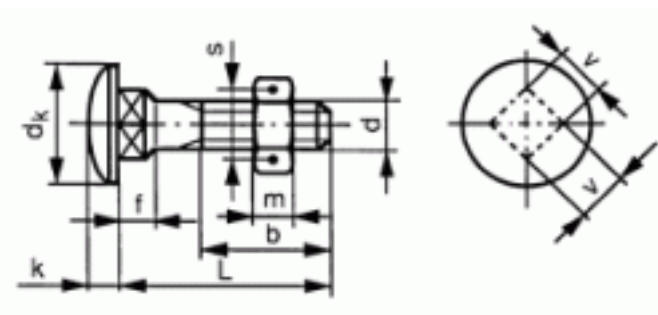

Brand	-
UBB Code	951351381961
UNSPSC Code	31161612
EAN Code	8715492560964
Thread	Metric thread
Class	≥4.6
Material	Steel
Surface treatment	Hot dip galvanized



L	90
d	M8
Packaging (Piece )	100.0



Copyright Fabory Group